

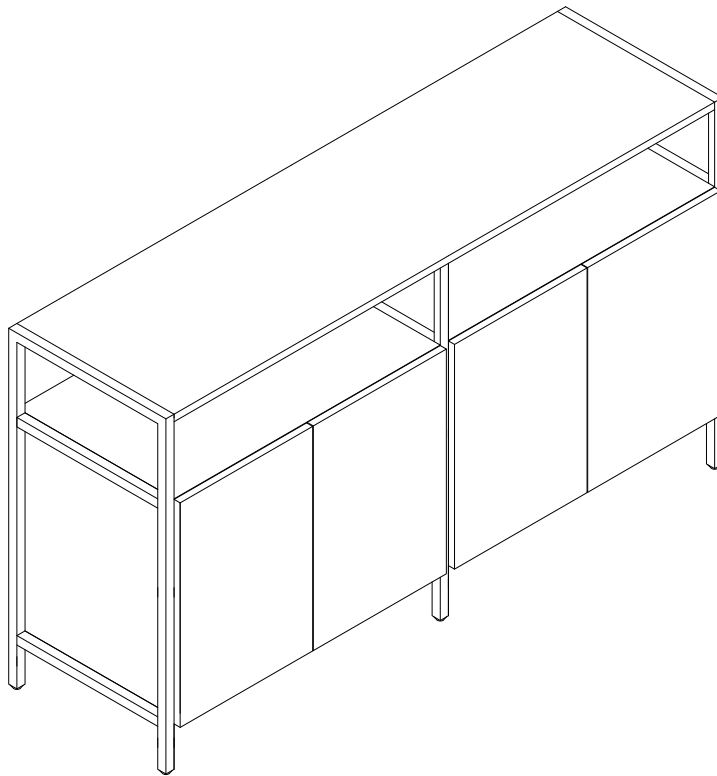

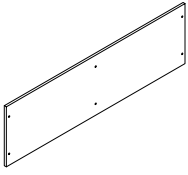

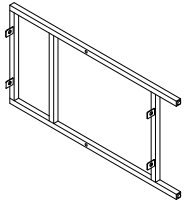

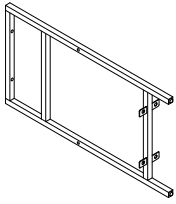

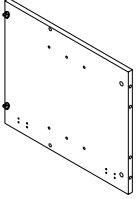
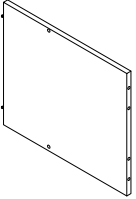
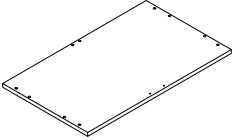
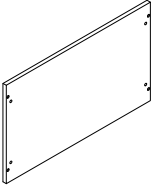
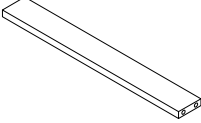
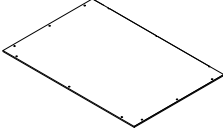
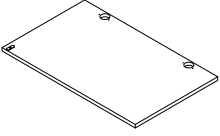
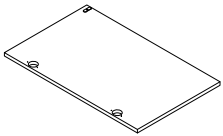
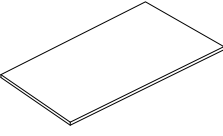

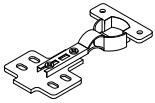

Media Stand
CF1318

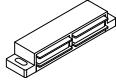

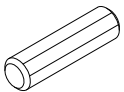
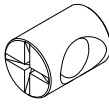
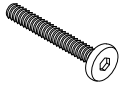
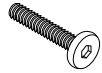
PART LIST

<p>A</p> 	<p>B</p> 	<p>C</p> 	<p>D</p> 	<p>E</p> 
<p>Top Panel 1 PC</p>	<p>Side Frame 2 PCS</p>	<p>Middle Frame 1 PC</p>	<p>Left Panel 2 PCS</p>	<p>Right Panel 2 PCS</p>
<p>F</p> 	<p>G</p> 	<p>H</p> 	<p>I</p> 	<p>J</p> 
<p>Fixed Shelf 2 PCS</p>	<p>Bottom Panel 2 PCS</p>	<p>Back Middle Brace 2 PCS</p>	<p>Back Panel 4 PCS</p>	<p>Left Door Panel 2 PCS</p>
<p>K</p> 	<p>L</p> 			
<p>Right Door Panel 2 PCS</p>	<p>Adjustable Shelf 2 PCS</p>			

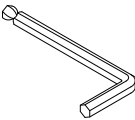
HARDWARE LIST

				
<p>Door Hinge 8 PCS</p>	<p>Flat Head Screw 48 PCS (Extra 1)</p>	<p>Double Magnet 2 PCS</p>	<p>Round Head Screw 4 PCS (Extra 1)</p>	<p>Shelf Holder 8 PCS</p>
				
<p>Wood Dowel 24 PCS (Extra 1)</p>	<p>Barrel Nut 8 PCS</p>	<p>Long Bolt 8 PCS (Extra 1)</p>	<p>Medium Bolt 2 PCS (Extra 1)</p>	<p>Short Bolt 8 PCS (Extra 1)</p>
				
<p>Bolt 12 PCS (Extra 1)</p>	<p>Flat Washer 12 PCS (Extra 1)</p>	<p>Allen Wrench 1 PC</p>	<p>Screw 42 PCS (Extra 1)</p>	<p>Safety Strap Kit 1 SET</p>

ADDITIONAL TOOLS (Not Provided)

Note: It is not recommended to use power tools during assembly.

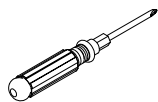

Phillips Head Screwdriver

Note: Wood dowels are intended for alignment. Additional clearance between wood dowel and pre-drilled hole is intentional for ease of assembly.

Please do not use tools to assemble this unit unless specifically indicated.

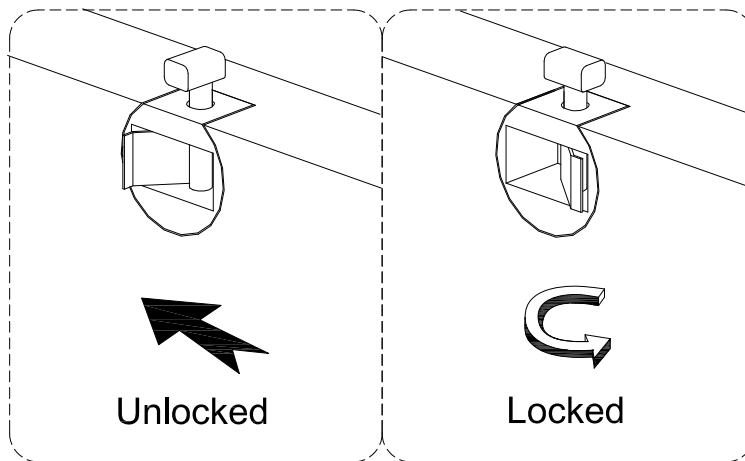



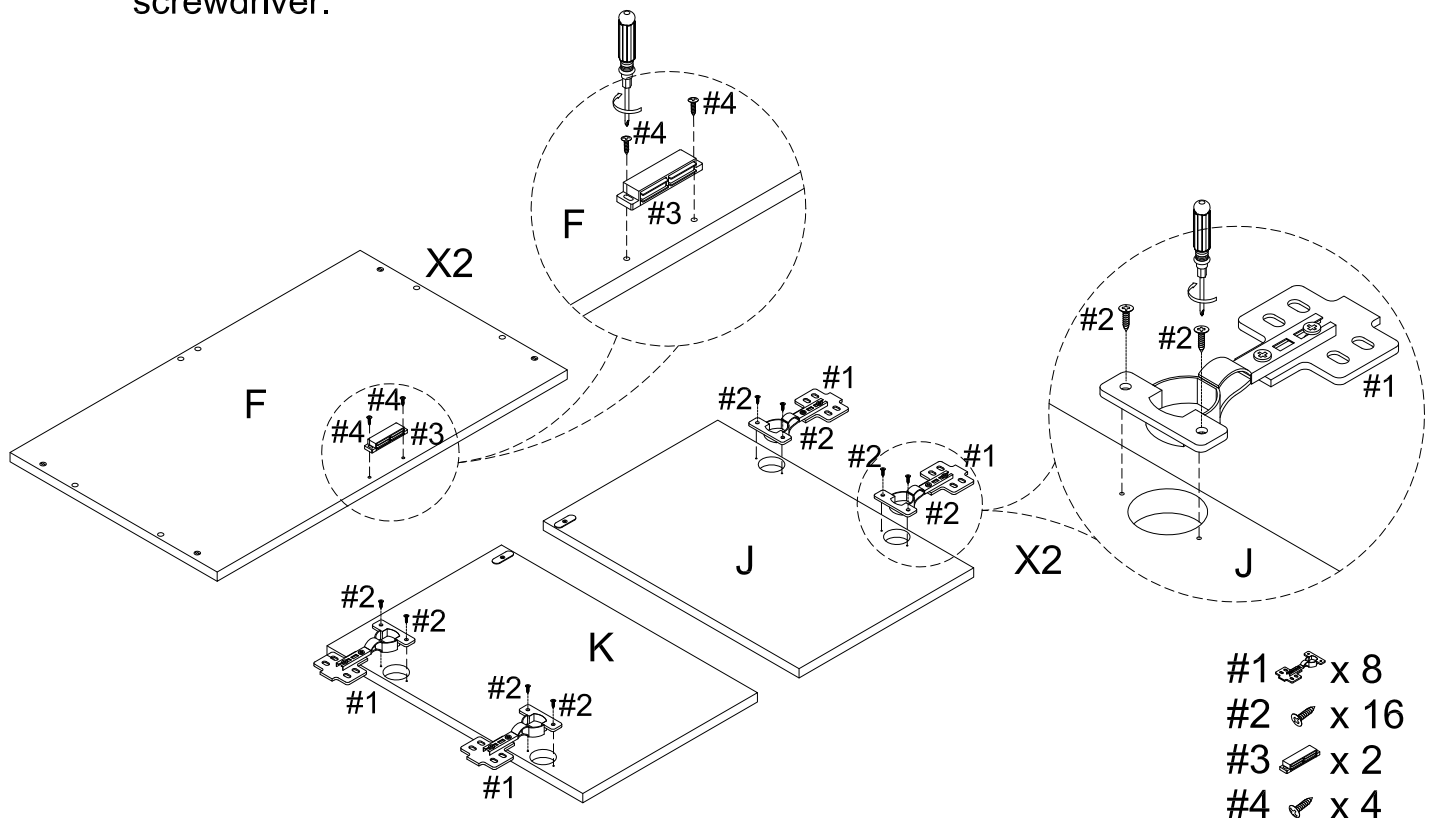

Reference the images above any time the instructions state "lock the hardware".
Note: Be sure to check all hardware is locked when completed.

Step 1. Attach double magnets (part #3) to fixed shelves (part F) using round head screws (part #4) and phillips head screwdriver. Attach door hinges (part #1) to door panels (parts J & K) using flat head screws (part #2) and phillips head screwdriver.

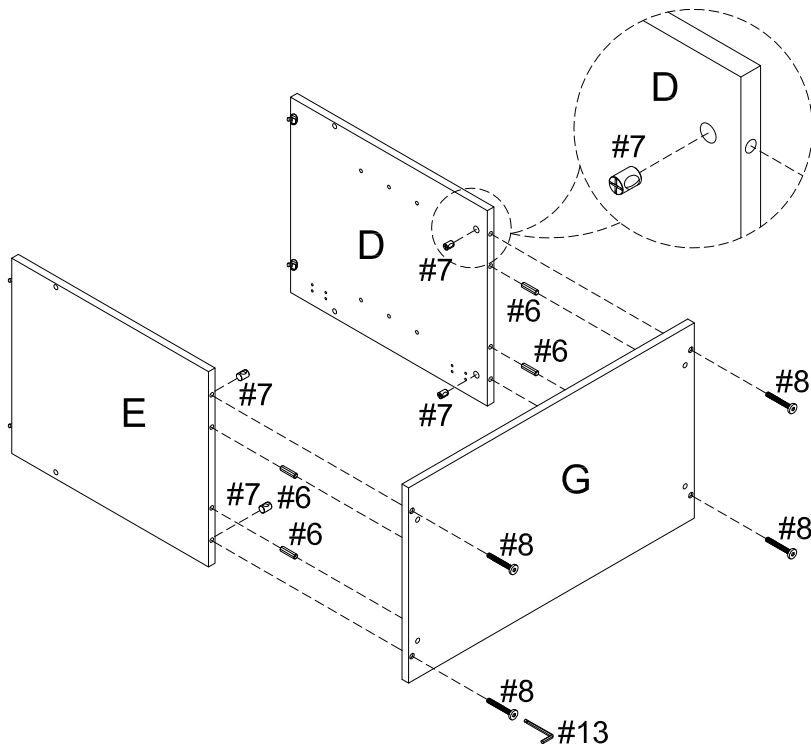



Step 2. Attach left panel (part D) and right panel (part E) to bottom panel (part G) using wood dowels (part #6), barrel nuts (part #7), long bolts (part #8) and allen wrench (part #13).

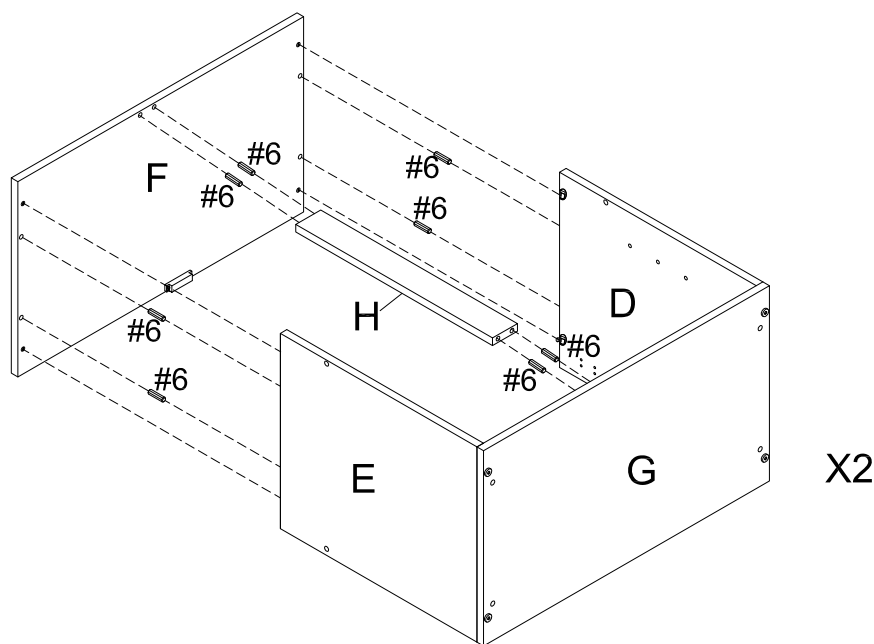

- #6  x 4
- #7  x 4
- #8  x 4
- #13  x 1

Step 3. Attach back middle brace (part H) and fixed shelf (part F) to assembled unit (parts D, E & G) using wood dowels (part #6) and lock the hardware. Repeat steps 2-3.



- #6  x 8

Step 4. Attach side frames (part B) and middle frame (part C) to assembled units (parts D, E & G) using short bolts (part #10), bolts (part #11), flat washers (part #12) and allen wrench (part #13).

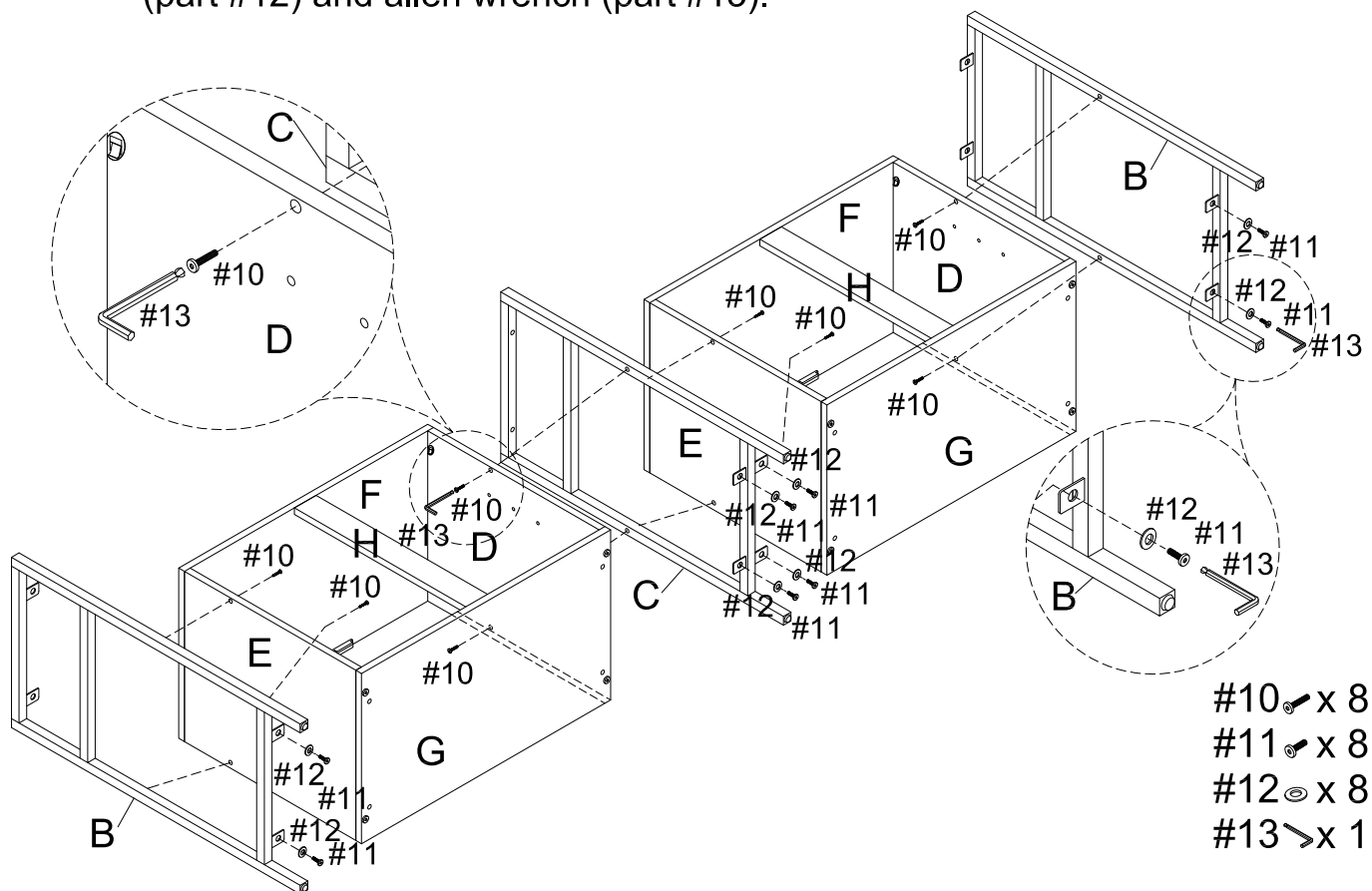

Step 5. Attach back panels (part I) to assembled unit (parts D, E, F, G & H) using screws (part #14) and phillips head screwdriver.

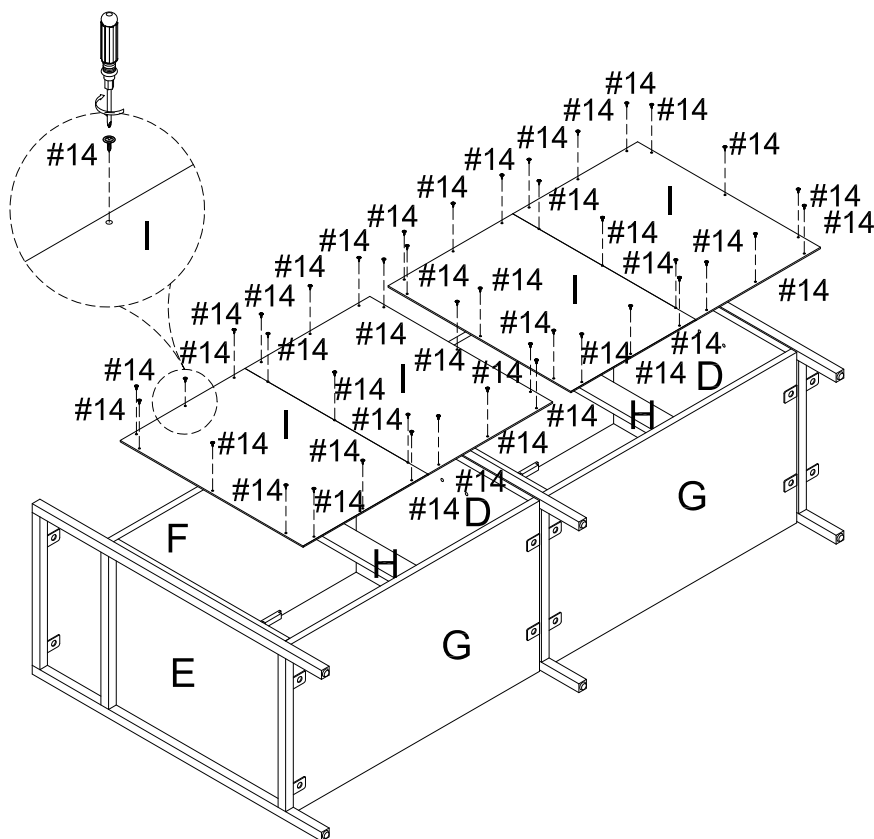

Step 6. Attach top panel (part A) to frames (parts B & C) using medium bolts (part #9), bolts (part #11), flat washers (part #12) and allen wrench (part #13).

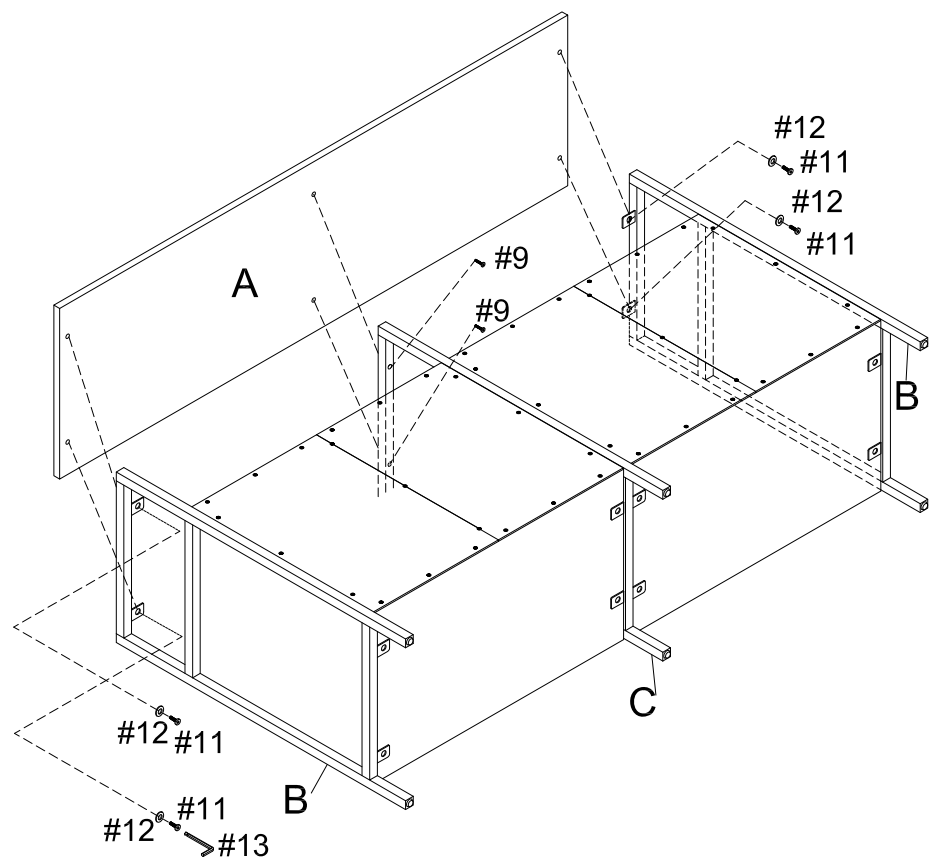

- #9  x 2
- #11  x 4
- #12  x 4
- #13  x 1

Step 7. Carefully turn unit upright. Place shelf holders (part #5) into desired position and then slide adjustable shelves (part L) into place.

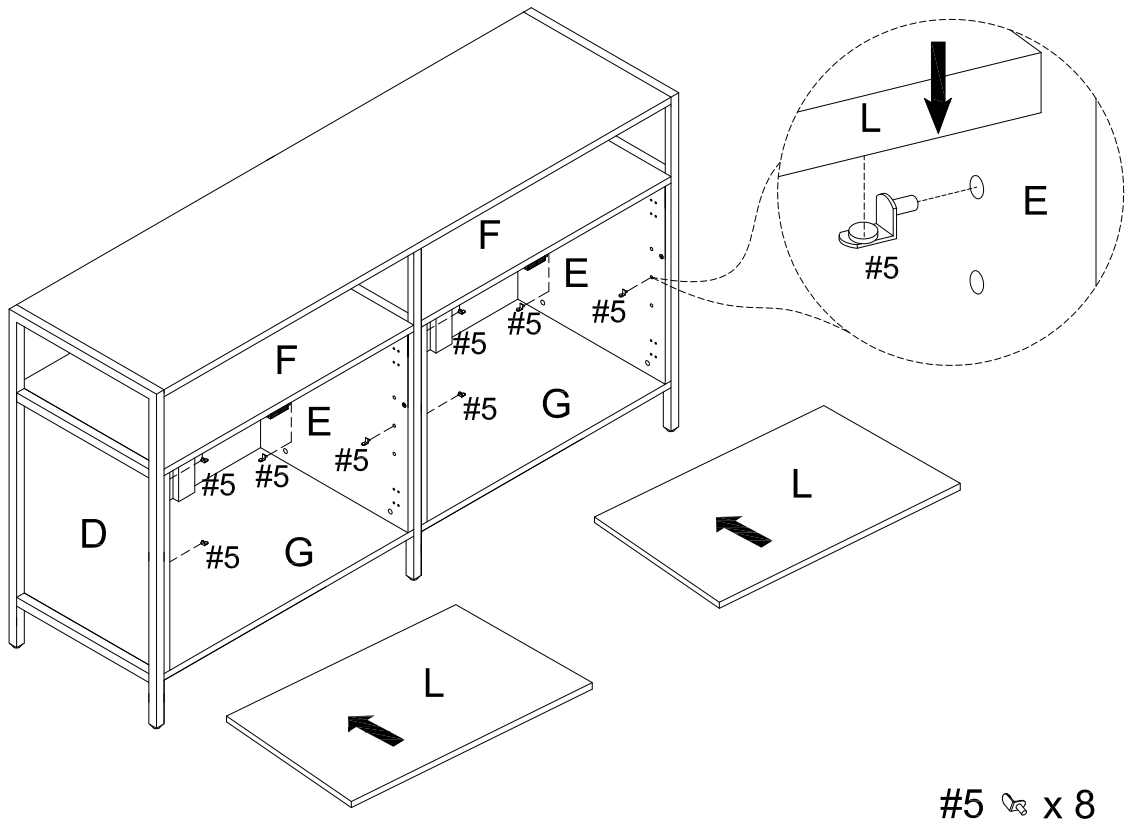





- #5  x 8

Step 8. Attach door panels (parts J & K) to panels (parts D & E) using flat head screws (part #2) and phillips head screwdriver.

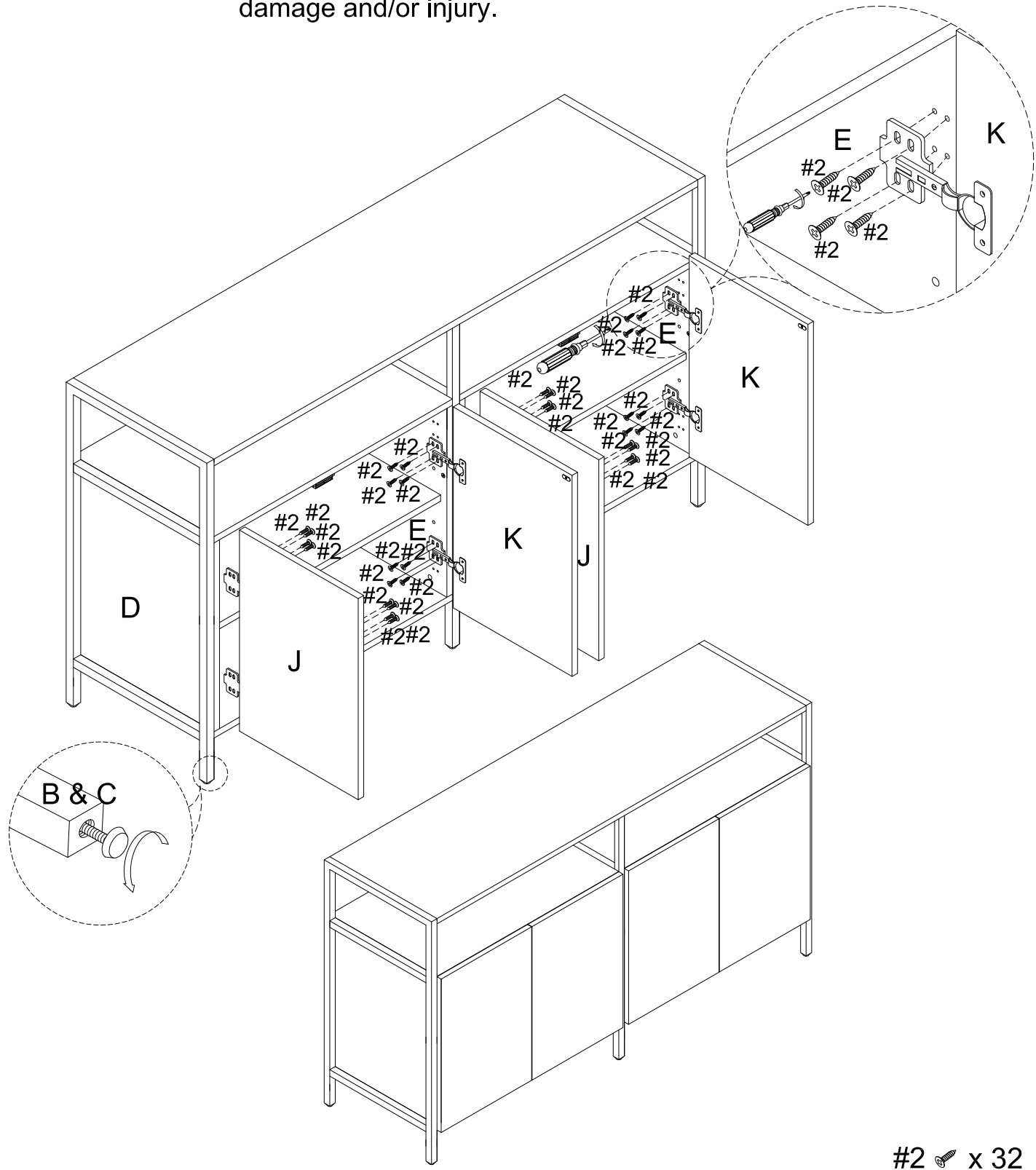
NOTE: It is important to adjust levelers once fully assembled and upright. Extend adjustable leveler until it's firmly in contact with the floor. If relocating, adjust leveler as needed until it's firmly in contact with the floor in new location.

Important: Safety strap kit (part #15) must be installed to prevent tipping, damage and/or injury.

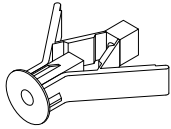

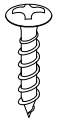
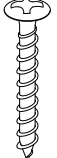
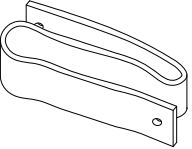
#15 	A 	B 	C  D8*3/4"	D  D8*1-1/2"	E 
Safety Strap Kit 1 SET	Wall Anchor 1 PC	Washer 2 PCS	Short Screw 1 PC	Long Screw 1 PC	Safety Wall Strap 1 PC

SAFETY WALL STRAP INSTALLATION

Note: It is highly recommended to install this safety strap kit to prevent tipping, damage and/or injury.

1. Insert short screw (C) through washer (B) and safety wall strap (E) and attach to top panel (part A) using phillips head screwdriver.

2. Drill a 11/32" hole where you want to secure the unit. The drilled hole will be at the same height as the hole in top panel (part A) where the safety wall strap (E) is attached. Tap wall anchor (A) into the hole.

3. Insert long screw (D) through washer (B) and safety wall strap (E) into wall anchor (A) using phillips head screwdriver.

Note: This item is not intended for clothing storage use.

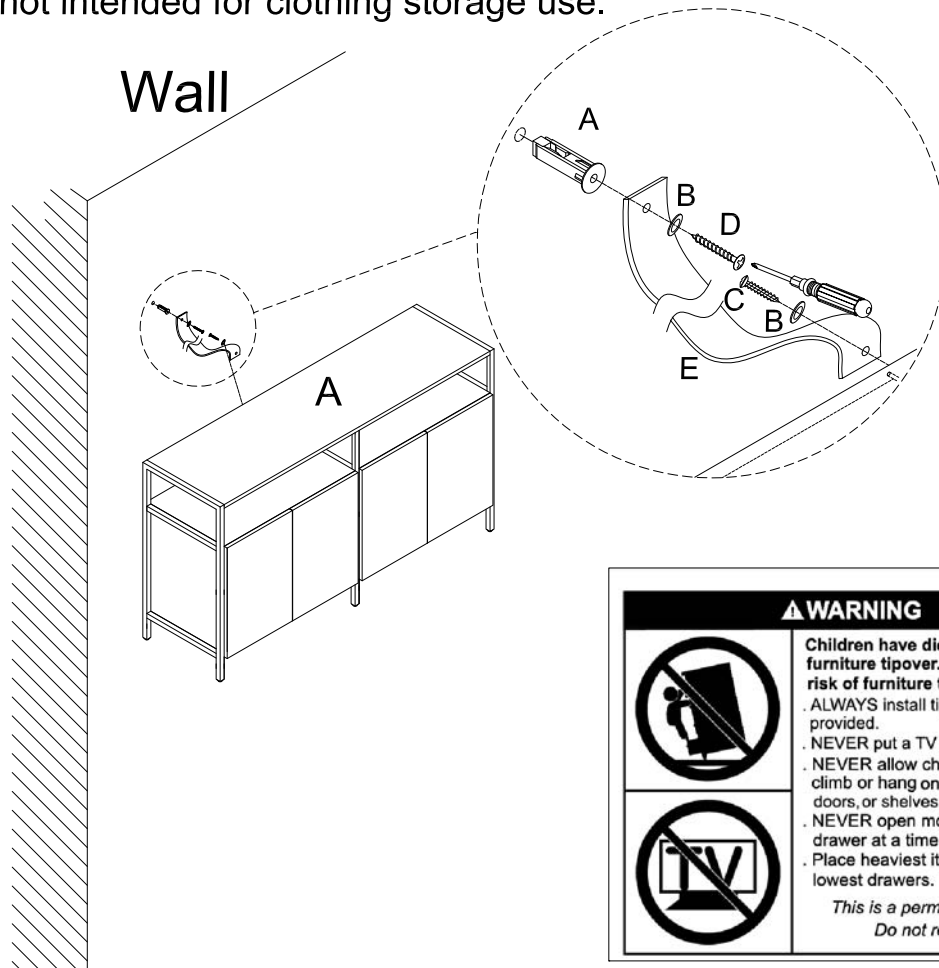

ADJUST YOUR DOORS TO MAKE THE GAPS MORE EVEN (OPTIONAL).

STEP 1

Open the door.

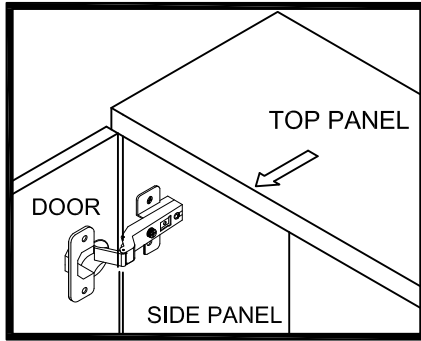

STEP 2

Adjust the gap between door panel and side panel

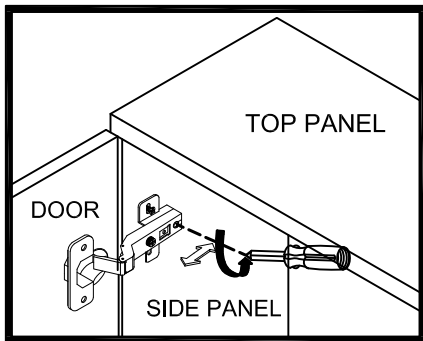

Loosen the screw indicated a little, adjust the hinge to right position (see step 2a & 2b), then tighten the screw.

STEP 2a MOVE DOOR IN

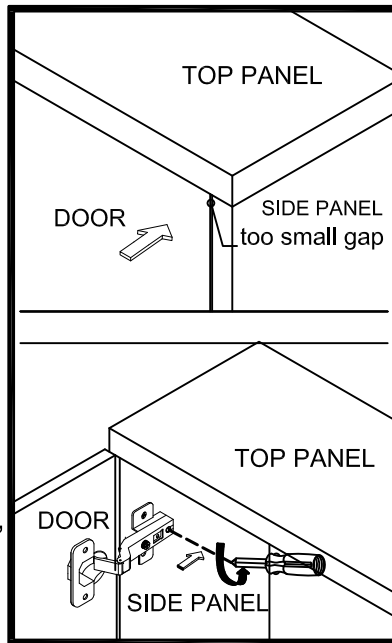

Push the hinge back a little.

STEP 2b MOVE DOOR OUT

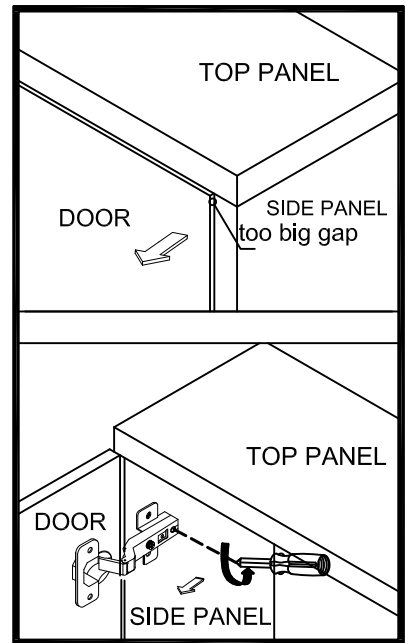

Pull the hinge forward a little.

STEP 3

To adjust the gap between two door

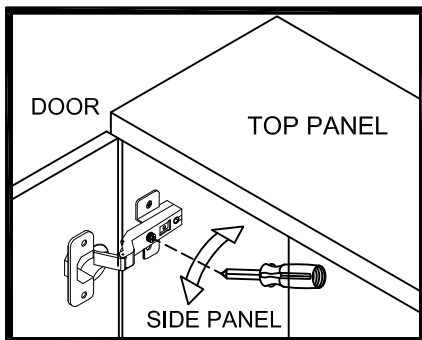

Loosen or tighten the screw indicated a little to adjust the gap between doors panels (see step 3a & step 3b)

STEP 3a MOVE DOOR RIGHT

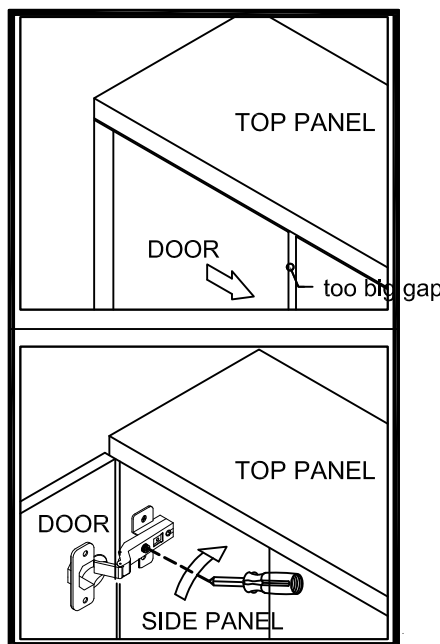

Turn the screw clockwise a little as shown to make the gap small.

STEP 3b MOVE DOOR LEFT

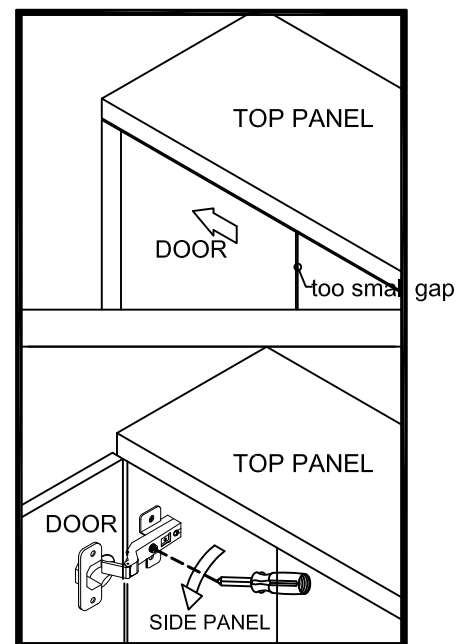

Turn the screw counterclockwise a little as shown to make the gap big.